

# CST(2FR) & CST(3FR)-Series

## INSTALLATION INSTRUCTIONS

### Material Application

For use in **horizontal joints**.

### Recommended Tools

- Tape Measure
- Sharp Knife
- Miter Saw
- Painters & Duct Tape
- Clean Cloth
- Isopropyl Alcohol
- Caulking Tool
- Jiffy Mixer
- Wood Wedges
- 2 Empty Clean Containers
- Margin Trowel

### Material Sizing

1. Check the material for appropriate length, width and depth.
2. Material sizing is based on the mean temperature field-measured joint widths. Supplied material should be pre-compressed to a size smaller than the intended opening.
3. Verify width of material supplied against the mean joint width. Joint depth must allow for the installed material to be recessed 1/8" - 1/4".

**WARNING:** Do not remove outer shrink wrapping from the FR Expansion Joint stick until you have read and understand the full instructions for proper installation. Failure to follow these directions may degrade fire endurance performance or make the material unsuitable (expanding before installed) for installation.

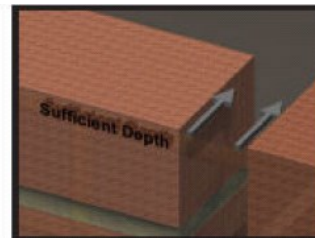
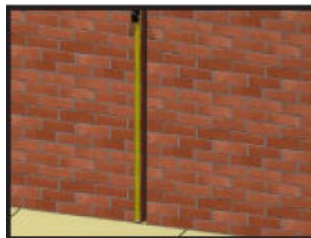

**NOTE:** Allow sufficient depth for the material to be recessed 1/8"–1/4" in the joint.

### Preparation of Joint Substrate

#### Concrete:

- Verify that the joint is clean, sound and will provide an appropriate surface for the installation of the joint sealant. Verify that the joint is uniform and that any spalls are repaired using proper materials and methods to ensure maintenance of the fire-rated wall assembly. Joint faces must be parallel.
- Joints must have a depth greater than or equal to the full depth of the material supplied plus 1/2" (6mm).
- Confirm joint substrate is dry and ready for the epoxy adhesive.

#### Metal:

- Confirm that the metal is clean and ready for the epoxy adhesive. Solvent-wipe the substrate just prior to applying epoxy.

**IMPORTANT:** Ensure that there is no rust or loose paint on metal substrates before the epoxy is applied.

This material has been tested to UL/ULC 2079 standards. Authorities having jurisdiction should be consulted in all cases as to the particular requirements covering the installation and use of UL Listed or Classified products. The published information cannot always address every construction nuance encountered in the field. When field issues arise, it is recommended to contact the product manufacturer. Users of the fire resistance assemblies are advised to consult the general Guide information for each product category and each group of assemblies. The Guide information includes specifics concerning alternate materials and alternate methods of construction. Only products which bear the UL's Mark are considered as Classified, Listed or Recognized.



## Preparation of Joint Substrate

### Gypsum (see detail in Appendix A)

- See UL for listed fire rated wall assemblies that yield the endurance rating equal to the installed FR expansion joint.
- For joints 3-1/4" and larger, use either 3/8" Hardiebacker® by James Hardie or PermaBase® Cement Board by National Gypsum Company, instead of 5/8" Gypsum Type X at joint face (depicted in solid gray in the detail in Appendix A).
- Adjust finish course of gypsum so it is flush with the cement board as shown.

---

## Epoxy Preparation

**\*\*Use blue painter's tape or other suitable tape to protect the exposed joint face.\*\***

1. Epoxy adhesive may be used in the >40°F (5°C) to 95°F (35°C) temperature range.
2. Mix part A and part B separately. Transfer the entire contents of Part B (hardener) into the contents of Part A (base).

**WARNING:** Part B must always be added Part A, and mixed in a 1:1 ratio.

3. Mix the material thoroughly with a low speed drill (300 rpm) and mixing paddle. Scrape the walls and bottom of the container to ensure uniform and complete mixing with no streaks.

**IMPORTANT:** DO NOT thin the epoxy.

### EPOXY TIPS:

1. The epoxy will not cure when the temperature is below 40°F.
2. For every +17°F the epoxy cures twice as fast.
3. For every -17°F the epoxy cures twice as slow.
4. Greater volume = less time to cure.
5. Smaller volume = more time to cure.
6. Mix only the required amount of the epoxy that will be used within 20-30 minutes to prevent the epoxy from curing prematurely.

This material has been tested to UL/ULC 2079 standards. Authorities having jurisdiction should be consulted in all cases as to the particular requirements covering the installation and use of UL Listed or Classified products. The published information cannot always address every construction nuance encountered in the field. When field issues arise, it is recommended to contact the product manufacturer. Users of the fire resistance assemblies are advised to consult the general Guide information for each product category and each group of assemblies. The Guide information includes specifics concerning alternate materials and alternate methods of construction. Only products which bear the UL's Mark are considered as Classified, Listed or Recognized.



## Epoxy Application to Substrate

**WARNING:** Epoxy will harden more quickly when left in the pot. Apply mixed epoxy onto the joint face as soon as possible.

**IMPORTANT:** The epoxy must still be uncured and tacky when installing the FR Expansion Joint sealant into the joint.

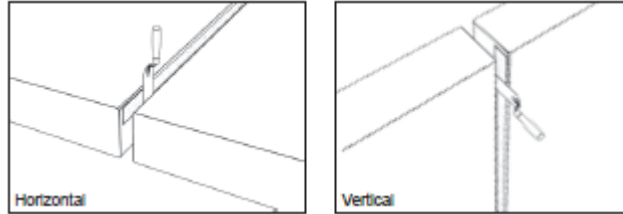

1. If the epoxy cures before installing the FR Expansion Joint, new epoxy can be reapplied within 2 hours.
2. After 2 hours, the substrate must be abraded to eliminate the amine blush that occurs during the final cure.

**IMPORTANT:** While others are applying the epoxy to the joint faces, others must prepare the FR Expansion Joint. The foam should be kept under compression in the original packaging.

3. Cut the plastic packing by cutting on the hardboard and remove hardboard and inner release liner. DO NOT cut along the silicone face.

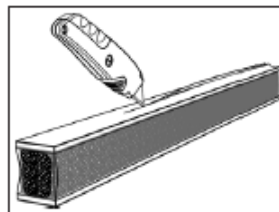

**IMPORTANT:** After cutting the shrink wrap, work quickly to avoid material expanding beyond a usable size.

## Wipe Release Agent off Silicone Facing

(not required for uncoated materials– proceed to next step)

- Silicone facing may be coated in the factory with a release agent. Prior to installation, this agent must be wiped off in order for the finish bead to adhere along the edge of the FR Expansion Joint.
- To remove the agent, lightly, quickly and thoroughly wipe the cured silicone facing with a lint-free rag, dampened with water. Repeat cleansing for all FR Expansion Joints as they are installed.



This material has been tested to UL/ULC 2079 standards. Authorities having jurisdiction should be consulted in all cases as to the particular requirements covering the installation and use of UL Listed or Classified products. The published information cannot always address every construction nuance encountered in the field. When field issues arise, it is recommended to contact the product manufacturer. Users of the fire resistance assemblies are advised to consult the general Guide information for each product category and each group of assemblies. The Guide information includes specifics concerning alternate materials and alternate methods of construction. Only products which bear the UL's Mark are considered as Classified, Listed or Recognized.

## Material Installation

1. After verifying that the epoxy on the joint substrate has not cured, install the FR Expansion Joint into the gap, starting from the bottom/end.
2. Apply a bead of the UL Approved Sealant to the base of the FR Expansion Joint and smooth to an even 1/16" (2mm) thickness.
3. Apply the supplied silicone along the top end edge of the installed silicone bellows (see example 1 below).
4. Apply the supplied UL Approved Sealant as shown to the end of the installed FR Expansion Joint (see example 2 below).
5. Flatten the supplied UL Approved Sealant on the end of the installed FR Expansion Joint to an even 1/16" (2mm) thickness (see example 3 below).
6. When the FR Expansion Joint material has expanded to a secure fit, it will support itself while the epoxy cures.
7. Starting from the bottom/end, insert the next FR Expansion Joint into the opening while securely pushing the two joint sections together to ensure there are no voids at the union joints. If a void is apparent, fill it with the supplied UL Approved Sealant.

**IMPORTANT:** UL Approved Sealant must be applied to top, bottom and all terminations and splices. This should always be done while the FR Expansion Joint is installed in the joint opening.

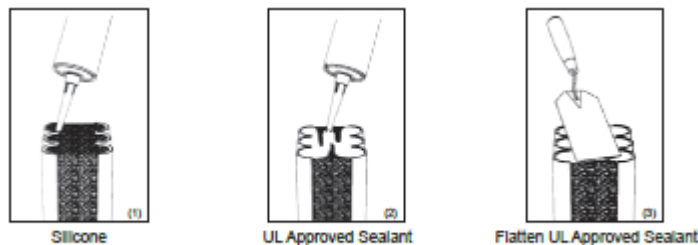

Examples are shown outside of the joint substrate for clarity only

8. Work in one direction towards the previously installed length or end of joint, making sure not to stretch the material.
9. Insert the uncoated bottom end of the stick into the joint and line it up with the previously installed stick. Coat the top end of the next stick with the supplied UL Approved Sealant as explained above. Securely compress the two pieces together. Ensure there are no voids at joint unions.

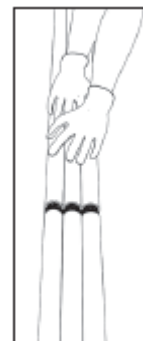

This material has been tested to UL/ULC 2079 standards. Authorities having jurisdiction should be consulted in all cases as to the particular requirements covering the installation and use of UL Listed or Classified products. The published information cannot always address every construction nuance encountered in the field. When field issues arise, it is recommended to contact the product manufacturer. Users of the fire resistance assemblies are advised to consult the general Guide information for each product category and each group of assemblies. The Guide information includes specifics concerning alternate materials and alternate methods of construction. Only products which bear the UL's Mark are considered as Classified, Listed or Recognized.



## Material Installation

**NOTE:** In cold temperature installations, provide as much ambient heat as possible around installed FR Expansion Joint to accelerate recovery.

10. Remove excess silicone left on the surface or material substrate. Be sure not to fill in the valleys of the bellows as this will constrain movement.
11. Remove any excess epoxy from the face of material using a clean, dry rag.
12. Install a bead along the edge of the joint and tool the silicone firmly to bond with the substrates and cured silicone facing, and to ensure a proper bond and seamless appearance.
13. Where the FR Expansion Joint meets at butt joints, tool the excess silicone that squeezes out from the top and between the bellows.

**IMPORTANT:** Silicone left between the fold or valleys of the bellows may constrain its movement—using a utility knife or caulking tool, remove excess sealant and smooth excess into the bellows.

**NOTE:** Silicone sealant is **ONLY** applied to the weather side of the foam. No sealant required on the other side.

**IMPORTANT:** Any FR Expansion Joint that terminates with an exposed end and not terminating into another stick or structural termination should be coated on the exposed foam end using the UL Approved Sealant. This will ensure the FR Expansion Joint is properly terminated. Only coat the FR Expansion Joint termination after it is installed in the joint or by applying the UL Approved Sealant to the terminating substrate.

---

## Fireproofing and UL Listing Information

Following these installation instructions will ensure that the FR Expansion Joint is installed as tested and meets UL 2079 standards. Failure to follow these installation instructions as described may result in the installed joint not complying with the UL Listing, as designed and tested, and therefore has potential life safety risks.

This material has been tested to UL/ULC 2079 standards. Authorities having jurisdiction should be consulted in all cases as to the particular requirements covering the installation and use of UL Listed or Classified products. The published information cannot always address every construction nuance encountered in the field. When field issues arise, it is recommended to contact the product manufacturer. Users of the fire resistance assemblies are advised to consult the general Guide information for each product category and each group of assemblies. The Guide information includes specifics concerning alternate materials and alternate methods of construction. Only products which bear the UL's Mark are considered as Classified, Listed or Recognized.



## Appendix A

Use either 3/8" Hardiebacker® by James Hardie or PermaBase® Cement Board by National Gypsum Company instead of 5/8" Gypsum Type X at joint face (depicted in solid gray).

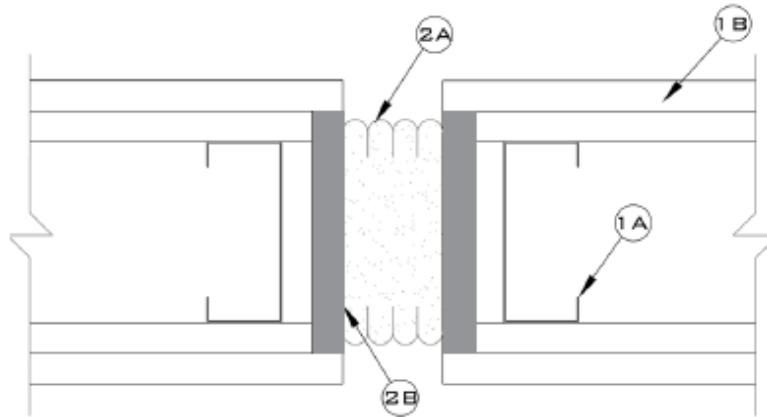

We recommend using a UL approved cement board at all joint interfaces. Through our extensive in house and independent UL lab testing, it is our observation that while FR Expansion Joint sealants pass the required hose stream component of UL 2079, there is an additional margin of safety in bonding to cement board over bonding to the paper covered gypsum interface.

See [www.ul.com](http://www.ul.com) for additional information

This material has been tested to UL/ULC 2079 standards. Authorities having jurisdiction should be consulted in all cases as to the particular requirements covering the installation and use of UL Listed or Classified products. The published information cannot always address every construction nuance encountered in the field. When field issues arise, it is recommended to contact the product manufacturer. Users of the fire resistance assemblies are advised to consult the general Guide information for each product category and each group of assemblies. The Guide information includes specifics concerning alternate materials and alternate methods of construction. Only products which bear the UL's Mark are considered as Classified, Listed or Recognized.

