

ELCW-Series Installation Instructions

ELASTOMERIC CORRIDOR SYSTEM – DRYWALL BEAD

MODEL(S): ELCW/ELCWw

ELCW Wall to Wall / Ceiling to Ceiling Cover System

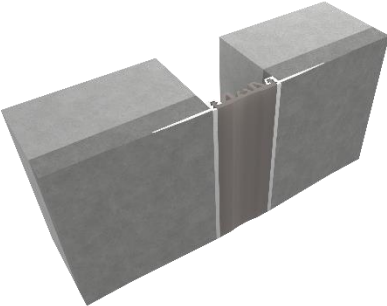

GENERAL DESCRIPTION

The ELCW Drywall Bead Elastomeric Corridor System limits the sight line of the expansion joint by using a drywall bead for mounting. The finished tape and four Santoprene seal color options to match your surroundings.

GENERAL SAFETY PRECAUTIONS Improper selection, installation, or use can cause personal injury or property damage. It is solely the responsibility of the user, through their own analysis, to select products suitable to the specific application requirements, ensure proper maintenance and use as intended. Follow local, state, and federal regulations for proper installation and operation requirements.

Introduction + Safety

Please read the complete instructions carefully before beginning any work. To ensure proper installation and performance of the product, the following actions must be completed by the installing contractor. Failure to do so will affect product warranty.

Transportation + Storage

- Inspect all shipments and materials for missing or damaged components and hardware.
- Material must be stored in a clean, dry location.

Preparation

- Locate the packing slip(s) and/or shop drawings.
- Verify that all products listed on the packing slip are included in the package.

- Check the products for damage. If products are damaged, report a freight claim immediately and leave the products in their packaging. If you sign for products without reporting damage, you waive your right to a freight claim and will be responsible for their replacement cost.
- Read the instructions thoroughly before beginning installation.

Tool List

- Tape measure
- Phillips
- Hex screwdriver
- Slotted Drivers for Anchors
- Levels
- Awls
- Masking tape
- Rubber mallet
- Wooden block
- Trowel
- Chop saw to cut product to length
- Electric drill with 5/32” masonry bit
- Broom & dustpan or vacuum
- Adhesive glue

Preinstallation

1. Ensure that the area where the expansion system is being installed is smooth and level.



INSTALLATION

1. Position aluminum extrusions in the expansion joint as shown and attach with appropriate fasteners (by others) for the substrate. 18" on center (stagger seams, as necessary). **See Figure 1**

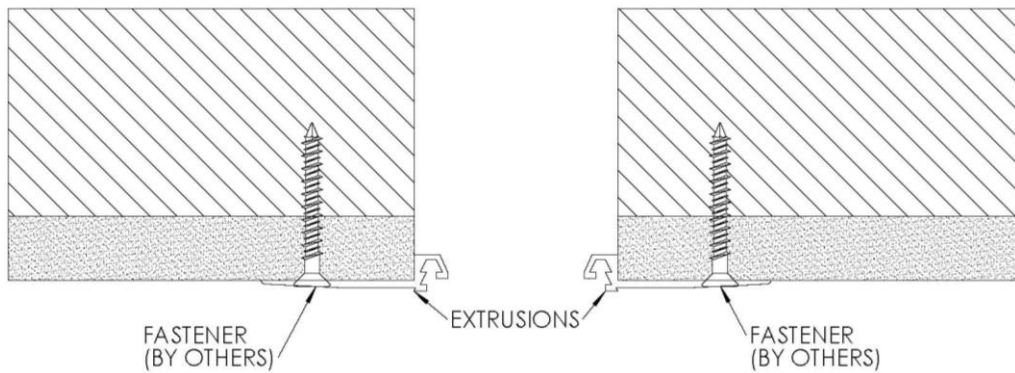

FIGURE 1

2. Position the elastomeric seal into position and push the seals bulbs into the extrusion channels as shown. Make sure the bulbs are seated all the way into the channel (stagger seams, as necessary). **See Figure 2**

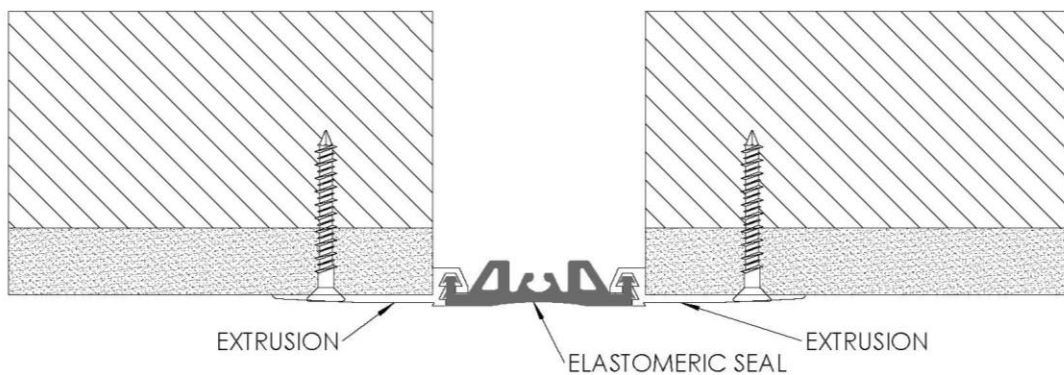

FIGURE 2

3. Protect the elastomeric seal with tape and feather joint compound (by others) over the exposed aluminum frames and onto the gypsum wallboard. Remove tape after wall or ceiling has been finished. **See Figure 3**

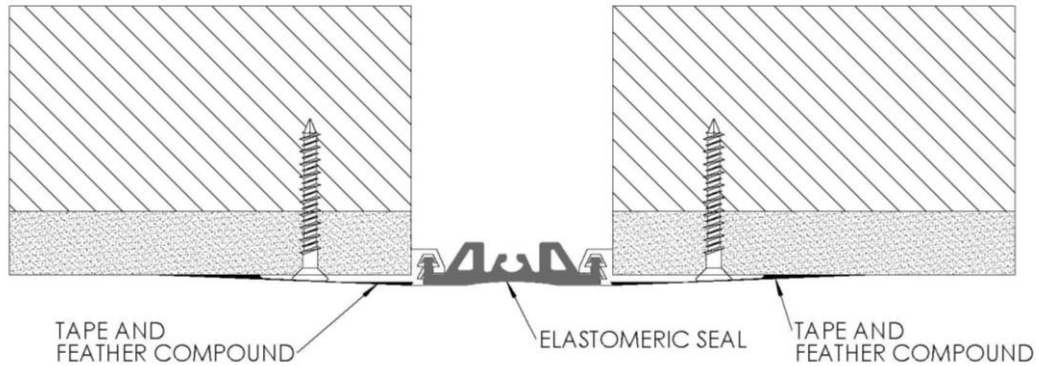
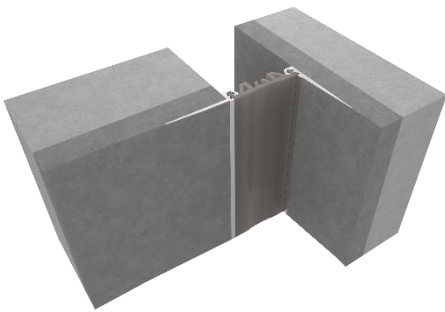

FIGURE 3

Interior Joints (Wall)

ELCWw Wall to Corner / Ceiling to Corner Cover System



GENERAL DESCRIPTION

EMS' ELCWw Interior Elastomeric System is designed to match the ELCW system in corner applications.

Preinstallation

1. Ensure that the area where the expansion system is being installed is smooth and level.



INSTALLATION

1. Position aluminum extrusions in the expansion joint as shown and attach with appropriate fasteners (by others) for the substrate. 18" on center. Make sure the corner extrusion is installed so the extrusions channels are level with each other (stagger seams, as necessary). **See Figure 4**

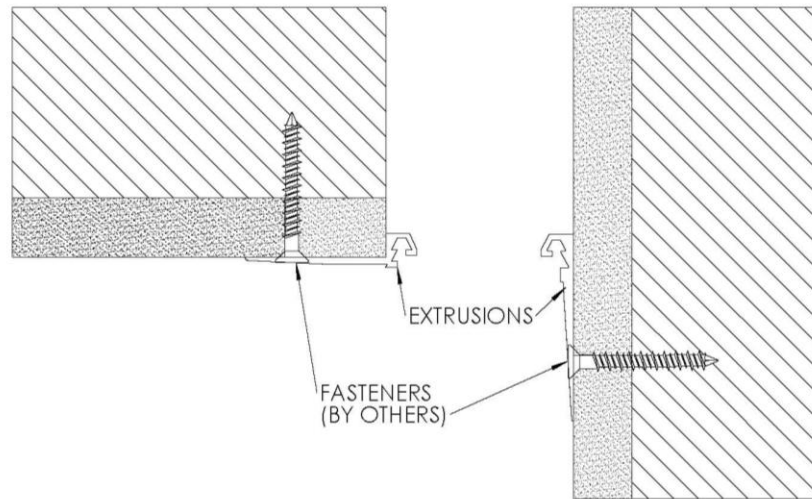

FIGURE 4

2. Position the elastomeric seal into position and push the seals bulbs into the extrusion channels as shown. Make sure the bulbs are seated all the way into the channel (stagger seams, as necessary). **See Figure 5**

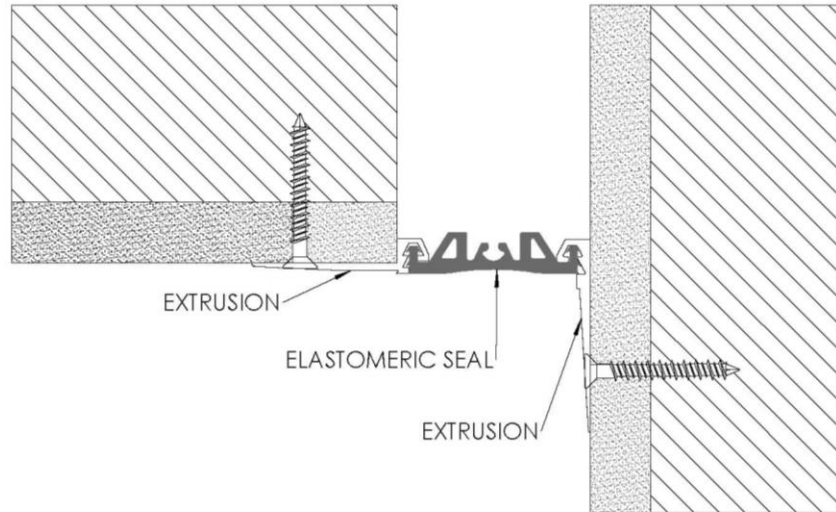

FIGURE 5

3. Protect the elastomeric seal with tape and feather joint compound (by others) over the exposed aluminum frames and onto the gypsum wallboard. Remove tape after wall or ceiling has been finished. **See Figure 6**

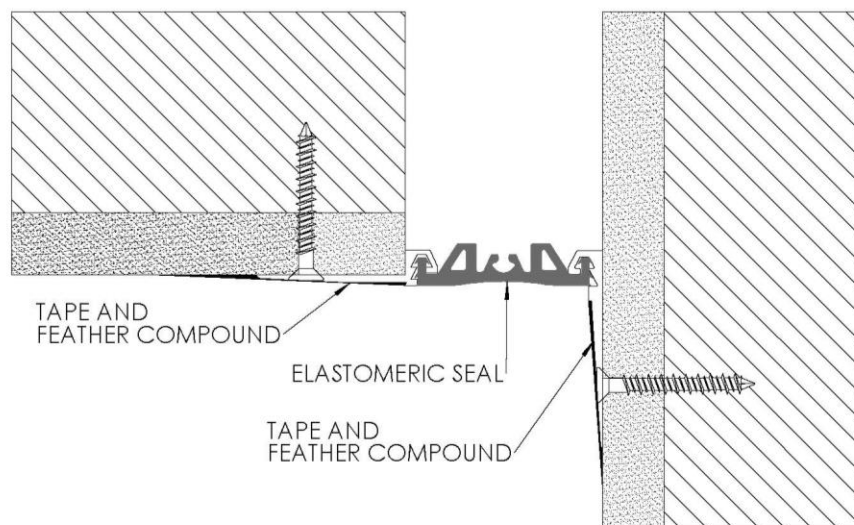

FIGURE 6

FIELD SPLICE FOR FLAT ELASTOMERIC SEAL

1. Determine the angle needed and cut ends of seal in a miter box with a sharp, non-serrated knife. **See Figure 1**

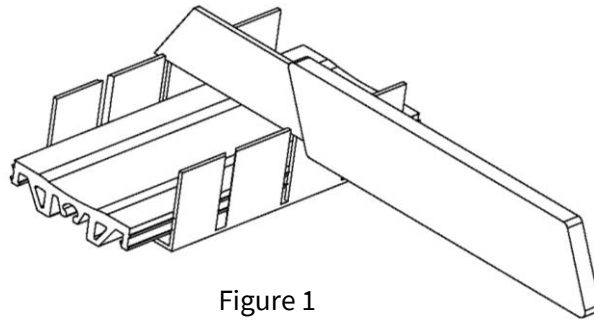

Figure 1

2. Using a solvent (by others) that is safe for elastomeric materials clean the ends of the seals. **See Figure 2**

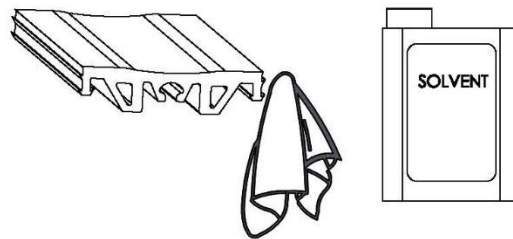

Figure 2

3. Apply a super glue, cyanoacrylate type (non-gel) or similar adhesive (by others) and follow instructions by the adhesive manufacturer. **See Figure 3**

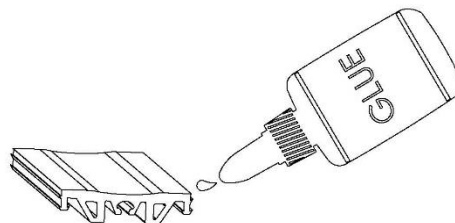

Figure 3

4. Check the splices after the adhesive has cured and reapply adhesive as necessary. Allow 15 minutes prior to installing seal. It typically takes 24 hours for adhesive to fully cure and achieve proper working strength. Ensure that the splice of the seal is not within 2” of a joint in the aluminum extrusion. **See Figure 4**

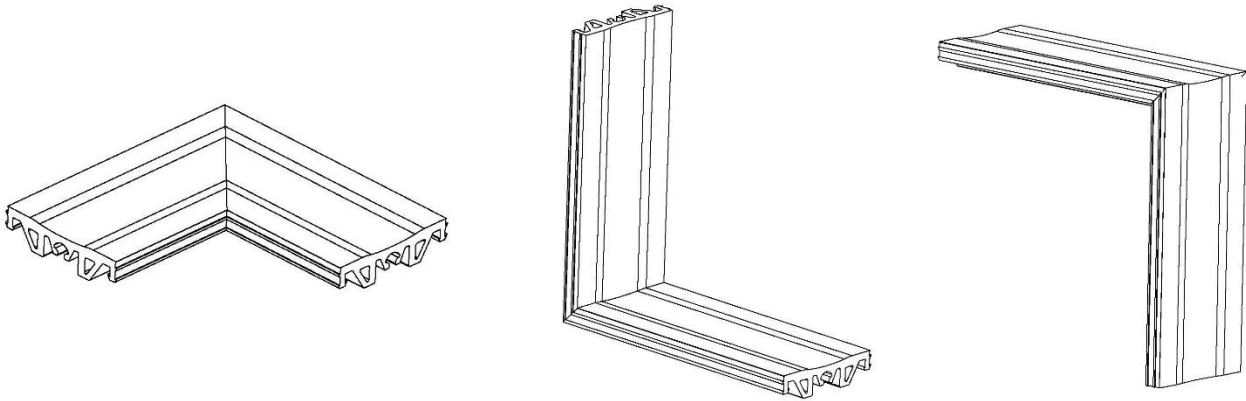

Figure 4