

# ESFP-Series Installation Instructions

## ARCHITECTURAL SEISMIC SYSTEM

**MODEL(S): ESFP/ESFPw**

### ESFP Floor to Floor Cover System

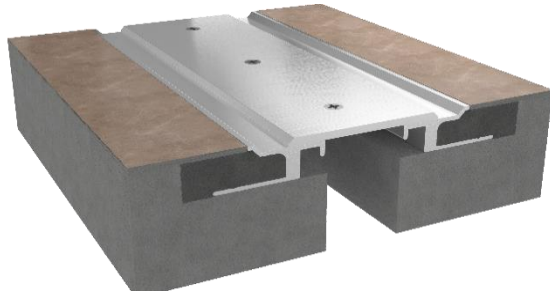

#### GENERAL DESCRIPTION

The ESFP Architectural Blockout/No Bump Seismic System is designed to cover expansion control openings in structural, high-movement floor joints, when standard aluminum is acceptable. The ESFP provides a no bump transition.

**GENERAL SAFETY PRECAUTIONS** Improper selection, installation, or use can cause personal injury or property damage. It is solely the responsibility of the user, through their own analysis, to select products suitable to the specific application requirements, ensure proper maintenance and use as intended. Follow local, state, and federal regulations for proper installation and operation requirements.

#### Introduction + Safety

Please read the complete instructions carefully before beginning any work. To ensure proper installation and performance of the product, the following actions must be completed by the installing contractor. Failure to do so will affect product warranty.

#### Transportation + Storage

- Inspect all shipments and materials for missing or damaged components and hardware.
- Material must be stored in a clean, dry location.

#### Preparation

- Locate the packing slip(s) and/or shop drawings.
- Verify that all products listed on the packing slip included in the package.
- Check the products for damage. If products are damaged, report a freight claim immediately and leave the products in their packaging. If you sign for products without reporting damage, you waive your right to a freight claim and will be responsible for replacement costs.
- Read the instructions thoroughly before beginning installation.



## Tool List

- Tape measure
- Phillips
- Hex screwdriver
- Slotted Drivers for Anchors
- Levels
- Awls
- Masking tape
- Rubber mallet
- Wooden block
- Trowel
- Chop saw to cut product to length
- Electric drill with 5/32" masonry bit
- Broom & dustpan or vacuum

## Included with the expansion joint system:

3/16" X 1-3/4" Tapcon fastener

## Preinstallation

1. Pour floors with blockouts as shown on shop drawings. The blockout should be a minimum of 2" wider than the exposed cover width by the specified depth.
2. Ensure that the blockout is smooth. High spots should be ground down and low spots filled in. Make sure the blockout is clean by sweeping and/or vacuuming.

## INSTALLATION

1. Remove the factory installed #10-24 screw that attaches the wing plate to the base member frame and retain for reinstallation later. *Note: In the 2", 4" and 6" sizes this step is not necessary as the wing plate and frame are one piece.* **See Figure 1**



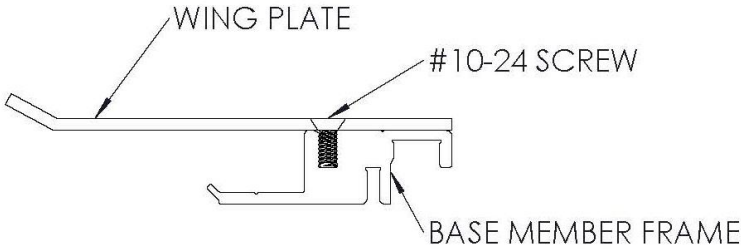

FIGURE 1

- 2. Position base member frames in blockout per shop drawings. Using the frame as a template mark, drill 5/32” holes for Tapcon fasteners. Install base member frames to the blockout opening with fasteners, making sure not to over tighten. **See Figure 2**

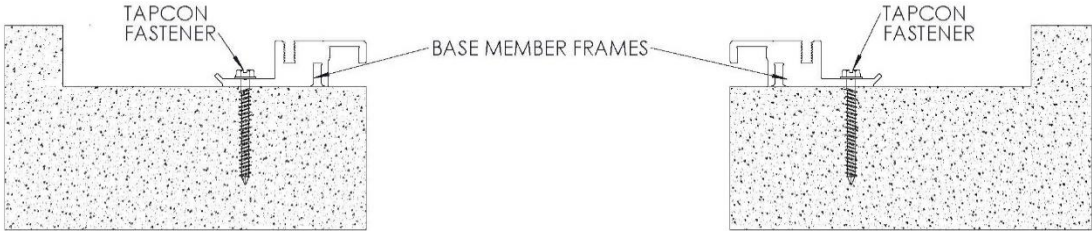

FIGURE 2

- 3. Reinstall the wing plate to the base member frame with the #10-24 screw. *Note: This step not necessary on the 2”, 4” and 6” sizes.* **See Figure 3**

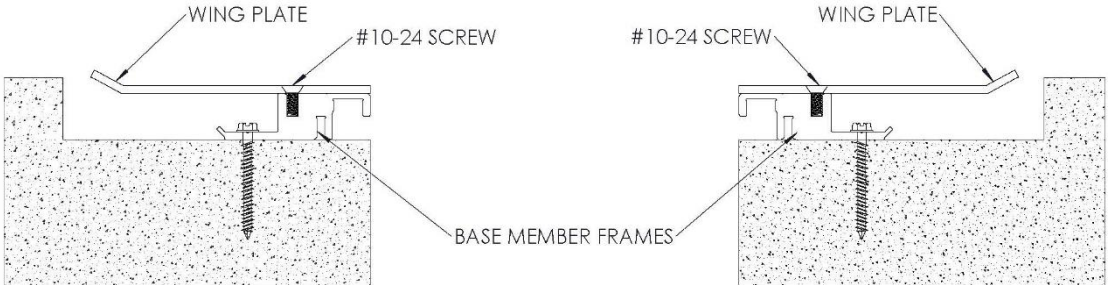

FIGURE 3

- 4. Protect the exposed surface of the expansion joint, grout in the blockout level with the surrounding floor. **See Figure 4**



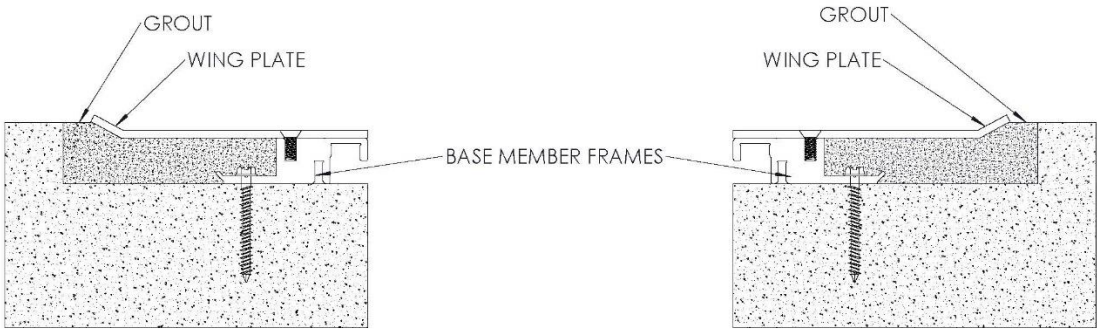

FIGURE 4

5. Finish floor may be installed after grout has cured. **See Figure 5**

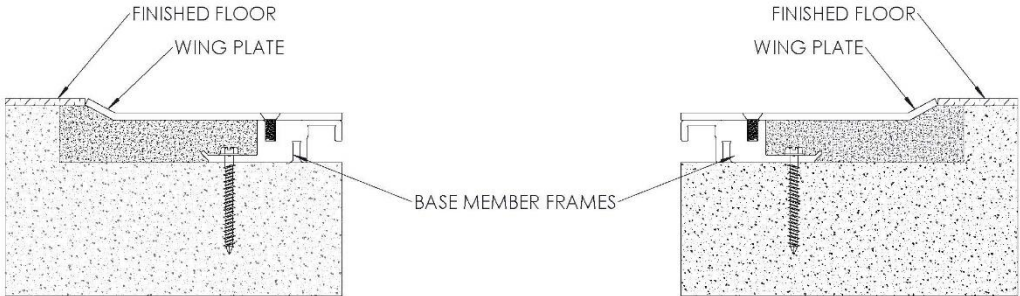

FIGURE 5

6. Lay cover plate over the left base frame with ends flush and mark cover plate center holes onto the base frame near the inside edge. Repeat this on the right side. Position the spring assembly in the spring track on the base frames. This is done by sliding the spring assemblies in from the ends of the frames and aligning them with the marked locations. The spring assemblies will be diagonal to the opening. Tape may be needed to hold the spring assembly in place. **See Figure 6**

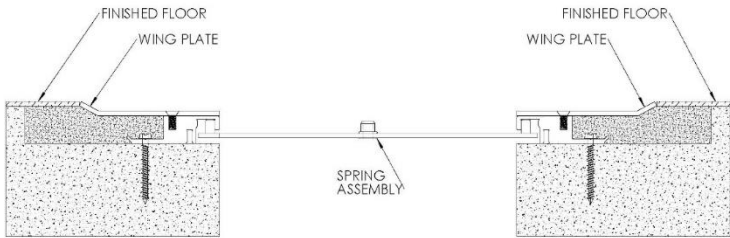

FIGURE 6



7. Position the cover plate centered over the base frame and with the center hole aligned with the spring assemblies. Attach the cover plate to the spring assemblies with the provided spring screws. **DO NOT OVERTIGHTEN. See Figure 7**

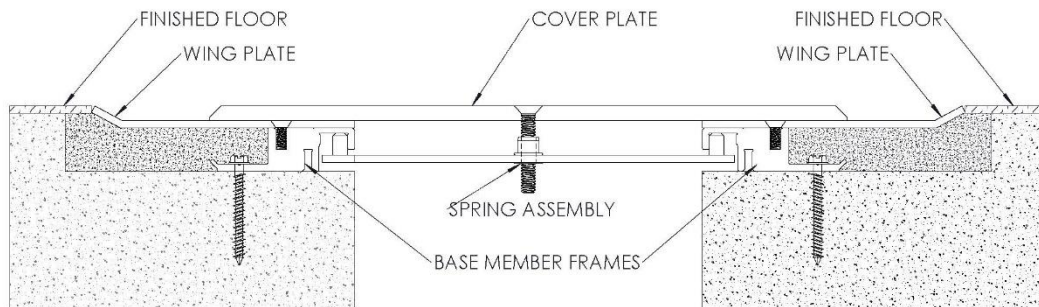
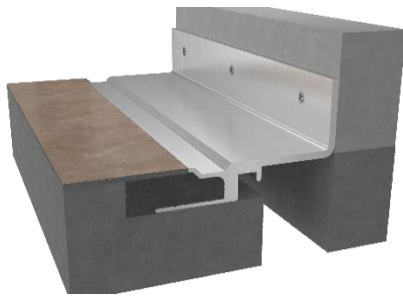

FIGURE 7

## ESFPw Floor to Wall Cover System



### GENERAL DESCRIPTION

The ESFPw Interior Cover System is designed to match the ESFP cover plate in floor to wall applications.

### Tool List

- Tape measure
- Phillips
- Hex screwdriver
- Slotted Drivers for Anchors
- Levels
- Awls
- Masking tape
- Rubber mallet
- Wooden block
- Trowel
- Chop saw to cut product to length
- Electric drill with 5/32" masonry bit
- Broom & dustpan or vacuum



### Included with the expansion joint system:

- 3/16" x 1-3/4" Tapcon fastener

### Preinstallation

1. Pour floors with blockouts as shown on shop drawings. The blockout should be a minimum of 1" wider than the exposed cover width by the specified depth.
2. Ensure that blockout is smooth. High spots should be ground down and low spots filled in. Make sure blockout is clean by sweeping and/or vacuuming.

### INSTALLATION

1. Remove the factory installed #10-24 screw that attaches the wing plate to the base member frame and retain for reinstallation later. *Note: In the 2", 4" and 6" sizes this step is not necessary as the wing plate and frame are one piece.* **See Figure 1**

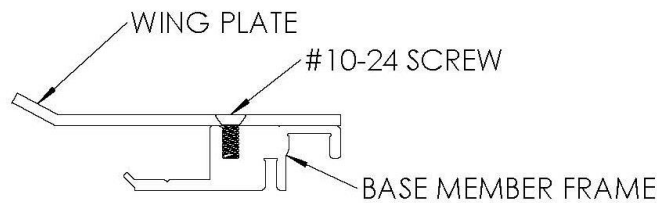

FIGURE 1



- 2. Position base member frame in blockout per shop drawings. Using the frame as a template, mark and drill 5/32” holes for Tapcon fasteners. Install base member frame to blockout opening with fasteners, making sure not to over tighten. **See Figure 2**

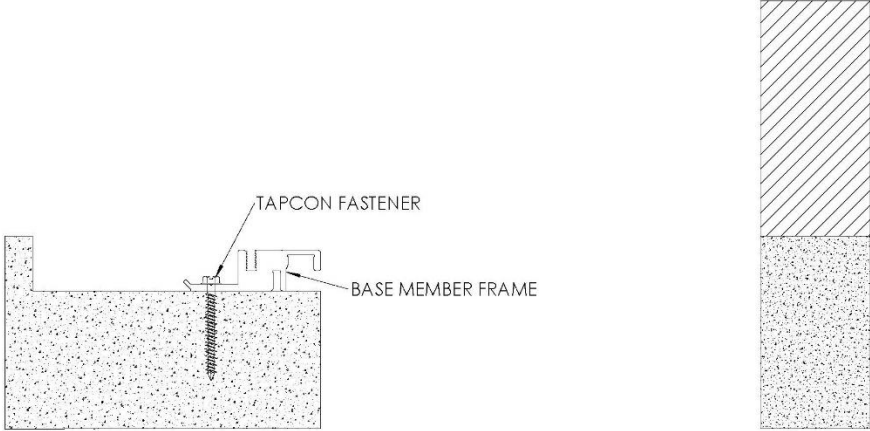

FIGURE 2

- 3. Reinstall the wing plate to the base member frame with the #10-24 screw. *Note: This step not necessary on the 2”, 4” and 6” sizes.* **See Figure 3**

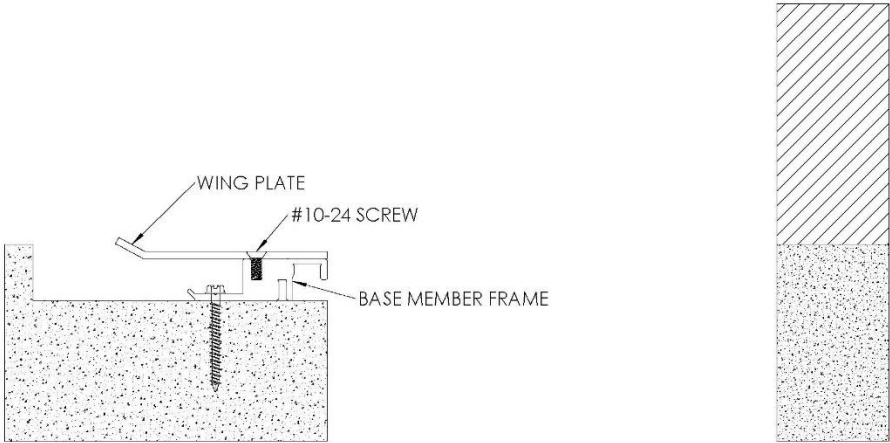

FIGURE 3

- 4. Protect the exposed surface of the expansion joint, grout in the blockout level with the surrounding floor. **See Figure 4**

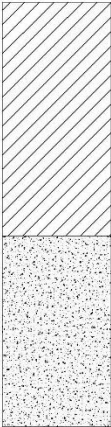
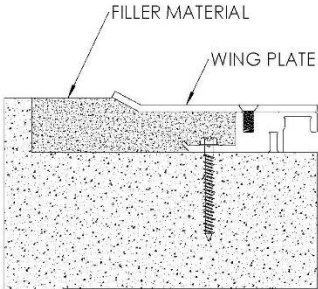

FIGURE 4

5. Finish floor may be installed after grout has cured. **See Figure 5**

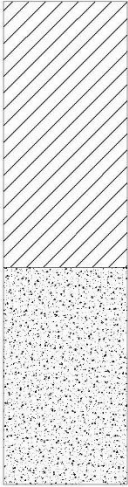
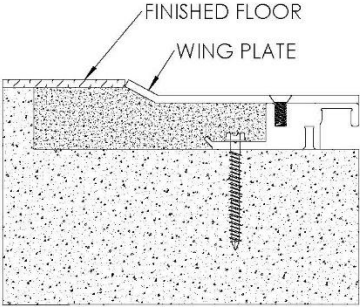

FIGURE 5





- 6. Position cover plate against wall as shown, making sure the top of its horizontal face is level when set on the wing plate. Attach plate to wall using appropriate 3/16" fasteners for the wall type, 18" o.c. *Note: Wall fasteners are not provided. See Figure 6*

Interior Joints (Floor)

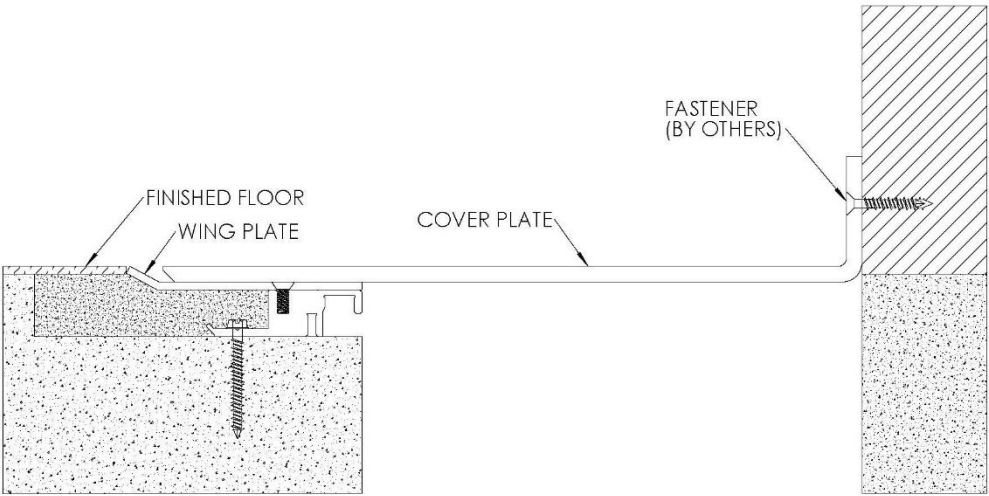

FIGURE 6

